

Metal Detector



Easy to use for anyone – Anritsu metal detectors offer a number of benefits.



Anritsu metal detectors are easy to use for anyone, which yields a range of benefits: improved inspection reliability, cost efficiency, and company credibility. These benefits contribute to the growth of your business and the creation of a safer, more secure society.





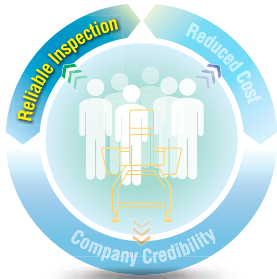

Reliable Inspection

Anritsu metal detectors feature high tolerance to vibration and electrical noise, minimizing false detection while maintaining product quality.

Heads are vibration and electric noise resistant

Metal detectors look for fluctuations within magnetic fields when product passes through the detector head. Since the magnetic fields are affected by external sources such as floor vibration and inverters from nearby machines, a metal detector must be designed to handle these challenges. With this in mind, Anritsu's detection heads were designed to provide high sensitivity without sacrificing repeatability and reliability.

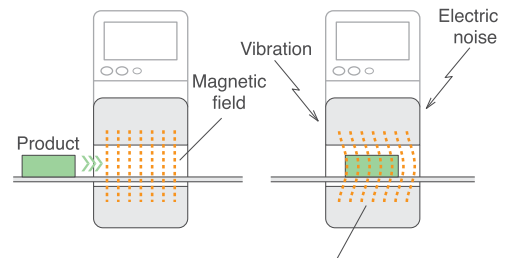

The detection head is highly resistant to external effects, accurately detecting even slight fluctuations.

Optimal sensitivity achieved by HIS (High Sensitivity) Setting

HIS (High Sensitivity) setting automatically analyzes product and contaminant properties and sets detection limits precisely for optimal contaminant detection.

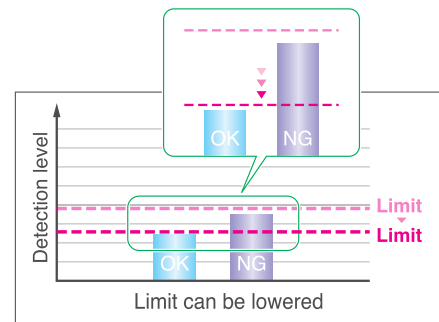

Auto-Limit and Auto-Tracking Function enhance repeatability and reliability

Auto-limit function automatically sets the best evaluation limit based on the variation of product effects. Auto-tracking function prevents false rejects by compensating for product temperature changes.

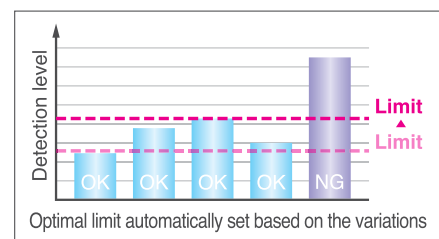

【Auto-Limit Function】



High sensitivity detection of both ferrous and non-ferrous metals

Anritsu has patented a dual-frequency system, which automatically determines best frequencies to maximize sensitivity for both ferrous and non-ferrous metals simultaneously. The contamination of stainless steel fragments dropped from a production equipment can be also detected.

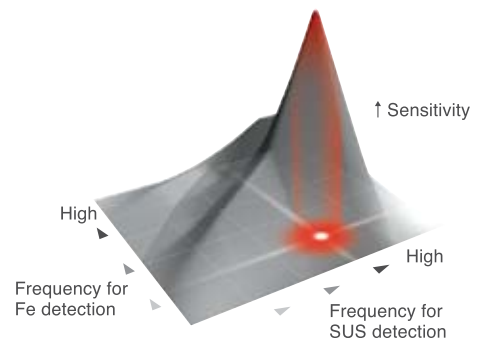

Optimized parameter setting anyone can achieve

On-screen instructions eliminate confusion and simplify product setup. The system automatically selects the best settings based on: speed, product parameters (dry/wet/aluminum film), etc. Even inexperienced operators can perform optimal parameter settings.



Simple maintenance

The conveyor belt can be easily removed/attached without tools. The waterproofed models' drive-belt-free direct-drive method facilitates easy and quick cleaning. The waterproofed models also feature an automatic tension adjustment capability and a belt misalignment prevention mechanism, which require less maintenance and minimize downtime.



Tool free belt removal

Auto-tension mechanism

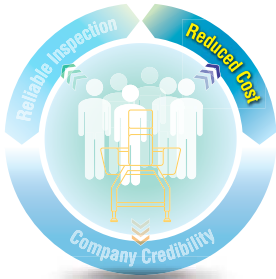

Reduced Cost

Intuitive touch-screen navigation prevents operator errors, improving operation efficiency as well as minimizing operator training costs.



Easy to understand instructions ensure proper proceedings even when the shift changes during a procedure.

Submenus can be hidden/shown as needed.

Smart Guide ensures correct operation checking

Metal detectors are considered a critical control point (CCP) in HACCP programs and continuous operation checking is required to meet standards. Smart Guide navigates operation check and maintenance procedures in an easy-to-understand format. When a procedure was performed incorrectly, it will not allow to proceed further, ensuring correct operation management. The time and costs for training operators can be minimized.



No operation manual is required with Product Registration Navigation

Product Registration Navigation simplifies parameter setting procedures with step-by-step illustrated instructions. You can save time and effort on reading through operation manuals or putting together training documents.



Multilingual display and global service network

11 different languages are selectable on screen for interface including English, Spanish, French, German, etc. We offer service networks in over 50 countries, ensuring that service, maintenance and repairs are carried out quickly and efficiently.



Simplified product changeover (Optional)

Product menus can be automatically selected by scanning product barcodes, allowing for simplified product changeovers even in diverse production lines.





Company Credibility

Advanced quality management help you earn customer loyalty.

Electronic daily report eliminates cumbersome manual data collection process

No matter how careful you are, human errors are inevitable in manual data collection. With Anritsu metal detectors, you can view all inspection data on the screen at any time and the data can be transferred to a PC via the USB port (inspection data is stored in .CSV format). Data and log management can be simplified, allowing for quick response to retailers' inquiries and enhancing your company's credibility.

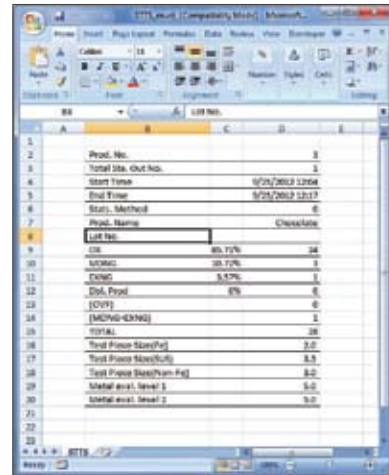

Advanced operator management

11 languages are selectable on-screen for interface, maximizing operator efficiency. Access levels assigned to each operator control which tasks an operator can perform, ensuring that all operators perform only the operations allowed to them. This maintains inspection quality and enhances the credibility of e-daily reports.



Provide product inspection certification (Optional)

QUICCA (overall quality management and control system) provides certification for HACCP program. You can show your clients that your manufacturing process uses and follows stringent quality control measures and can secure clients' confidence and trust.

Note: Anritsu is not responsible for the inspection results by this documentation.



For higher level quality control, refer to [QUICCA](#) brochure.

Rejection Confirmation

Contaminated products should not only be detected but also rejected properly. Rejection Confirmation Function of Anritsu rejectors continuously monitors rejection operation to ensure rejected products are fully removed from the line.

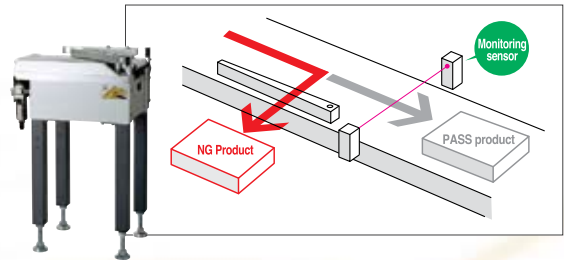

**OVER
40,000
units installed**
(as of March 2013)

Anritsu Industrial Solutions started manufacturing metal detectors in 1981 and its cumulative sales have reached over 40,000 units.

Anritsu designs and develops all its products in-house to support every solution with 100% confidence. Anritsu's sales and service network keeps your production lines running at top form and efficiency. Anritsu is dedicated to meeting your strict demands for quality — both through our products and through our support.

Lineup



duw-h

Enhancement to the standard dual-wave technology include improved signal processing and head design for optimal sensitivity and system stability. Features include enhanced operability such as operation guidance and E-daily report.

Detection head	<input checked="" type="checkbox"/> duw-h	<input type="checkbox"/> duw
Protection	<input checked="" type="checkbox"/> IP66	<input checked="" type="checkbox"/> IP30
Operation	<input checked="" type="checkbox"/> Touch panel	<input type="checkbox"/> Flat panel key
Data output	<input checked="" type="checkbox"/> USB	<input checked="" type="checkbox"/> Ethernet



duw

Simultaneous dual frequency metal detection – optimized for both Stainless Steel and Ferrous Metals at the same time. Provides extensive lineup ranging from for small bags to for large cartons to meet diverse application needs.

Detection head	<input type="checkbox"/> duw-h	<input checked="" type="checkbox"/> duw
Protection	<input checked="" type="checkbox"/> IP66	<input checked="" type="checkbox"/> IP30
Operation	<input type="checkbox"/> Touch panel	<input checked="" type="checkbox"/> Flat panel key
Data output	<input type="checkbox"/> USB	<input type="checkbox"/> Ethernet



duw-h series duw series

Detection heads, including indicators, are available for sale.

Contact our sales representatives for details.



Test Piece

Test pieces of Fe sphere, SUS304 sphere, SUS wire and non-ferrous metal sphere in varied sizes are available.



Metal detector for aluminum packaged products

Through magnetoreflexion technology, Anritsu's M-Series Metal Detector achieves high-sensitivity detection of metals that can be magnetized including stainless steel fragments. As its detection process is not affected by the aluminium package, the M Series Metal Detector is ideal for aluminium packaged products such as chocolate and pouch products. It is also unsusceptible to water and salt contents and can be used for frozen and high-salinity products.

Option

Tower light (with buzzer alarm)

Supports remote monitoring.



Emergency stop switch

Stops equipment in emergencies.



Line height change

Line height is adjustable by changing screw legs.



Plate for anchor

Secures units firmly in position.



Casters

Make it easier to move around.



CE & FCC marking

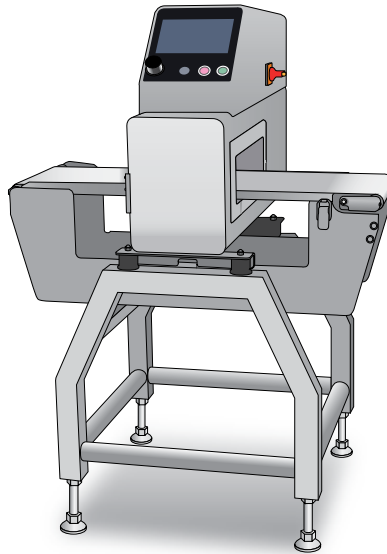

Cross plate

Provides smooth product transitions and prevents product accumulation.



Cross roller

Provides smooth product transitions and prevents product accumulation.



Scraper

Removes adherent objects from a conveyor belt surface.



Guide bank

Keeps bulk products from falling off the conveyor belt.



Product guide

Provides accurate product positioning on conveyors.

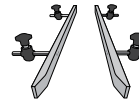

Buzzer

Makes a buzzing sound when an abnormal event occurs.



Data printer

Prints inspection results.



Rejector

Flipper

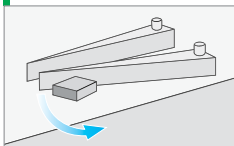

Highly versatile

Cartons
Thick bags

Dropout

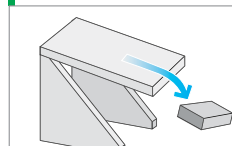

For thin products

Thin bags
Sheets

Air jet

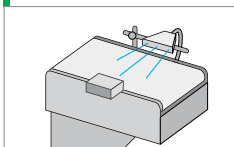

High speed

Light individual-packaged products

Up and Out

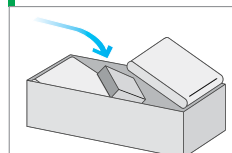

For thin products

Thin bags
Sheets

Pusher

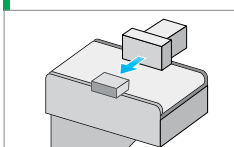

Gentle handling

Cartons

Carrier

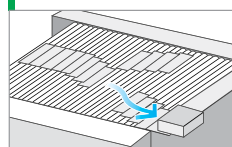

For open-topped containers

Cans
Jars

Anritsu

Anritsu Industrial Solutions USA Inc.

1001 Cambridge Drive Elk Grove Village, IL 60007-2453

Phone (847)419-XRAY(9729) Fax (847)537-8266

<http://www.detectionperfection.com>

CAT. NO. K3163-A-1



ISO14001 CERTIFICATE No.JQA-EM0210
ISO 9001 CERTIFICATE No.JQA-0566
© ANRITSU INDUSTRIAL SOLUTIONS CO., LTD. 2013

- To ensure proper operation, read the Operation Manual before using the machine.
- In addition to daily inspection, an annual maintenance check should be carried out.

Specifications are subject to change without notice.

No part of this catalog may be reproduced without our permission.

Printed on Recycled Paper

2013-09 (ddc/CDT) Printed in Japan